

BALDOR® • RELIANCE 

Product Information Packet

EWCM3713T

15HP,3500RPM,3PH,60HZ,215TCZ,3752M,TEFC

Part Detail							
Revision:	H	Status:	PRD/A	Change #:		Proprietary:	No
Type:	AC	Elec. Spec:	37WGR228	CD Diagram:	CD0180	Mfg Plant:	
Mech. Spec:	37N046	Layout:	37LYN046	Poles:	02	Created Date:	05-19-2015
Base:	RG	Eff. Date:	09-06-2019	Leads:	9#14		

Specs			
Catalog Number:	EWCM3713T	Heater Indicator:	No Heater
Enclosure:	TEFC	Insulation Class:	F
Frame:	215TCZ	Inverter Code:	Inverter Ready
Frame Material:	Steel	KVA Code:	J
Output @ Frequency:	15.000 HP @ 60 HZ	Lifting Lugs:	Standard Lifting Lugs
Synchronous Speed @ Frequency:	3600 RPM @ 60 HZ	Locked Bearing Indicator:	Locked Bearing
Voltage @ Frequency:	460.0 V @ 60 HZ	Motor Lead Quantity/Wire Size:	9 @ 14 AWG
	230.0 V @ 60 HZ	Motor Lead Exit:	Ko Box
XP Class and Group:	None	Motor Lead Termination:	Flying Leads
XP Division:	Not Applicable	Motor Type:	3752M
Agency Approvals:	UR	Mounting Arrangement:	F1
	CSA EEV	Power Factor:	89
	CSA	Product Family:	General Purpose
Auxillary Box:	No Auxillary Box	Pulley End Bearing Type:	Ball
Auxillary Box Lead Termination:	None	Pulley Face Code:	C-Face
Base Indicator:	Rigid	Pulley Shaft Indicator:	Tapped & Key
Bearing Grease Type:	Polyrex EM (-20F +300F)	Rodent Screen:	None
Blower:	None	Shaft Extension Location:	Pulley End

Current @ Voltage:	17.000 A @ 460.0 V	Shaft Ground Indicator:	No Shaft Grounding
	34.000 A @ 230.0 V	Shaft Rotation:	Reversible
	36.800 A @ 208.0 V	Shaft Slinger Indicator:	No Slinger
Design Code:	A	Speed Code:	Single Speed
Drip Cover:	No Drip Cover	Motor Standards:	NEMA
Duty Rating:	CONT	Starting Method:	Direct on line
Electrically Isolated Bearing:	Not Electrically Isolated	Thermal Device - Bearing:	None
Feedback Device:	NO FEEDBACK	Thermal Device - Winding:	None
Front Face Code:	Standard	Vibration Sensor Indicator:	No Vibration Sensor
Front Shaft Indicator:	None	Winding Thermal 1:	None
		Winding Thermal 2:	None

Nameplate NP3441L										
CAT.NO.	EWCM3713T									
SPEC.	37N046R228G1									
HP	15									
VOLTS	230/460									
AMP	34/17									
RPM	3500									
FRAME	215TCZ				HZ	60		PH	3	
SER.F.	1.15		CODE	J		DES	A		CL	F
NEMA-NOM-EFF	91		PF	89						
RATING	40C AMB-CONT									
CC	010A				USABLE AT 208V			36.8		
DE	6309				ODE	6206				
ENCL	TEFC		SN							
VPWM INVERTER READY										
CT6-60H(10:1)VT3-60H(20:1)										

Parts List		
Part Number	Description	Quantity
SA301066	SA 37N046R228G1	1.000 EA
RA288137	RA 37N046R228G1	1.000 EA
37FN3002B01	EXFN, PLASTIC, 7.50 OD, 1.155 ID	1.000 EA
HW3200A01	3/8-16X3/4 I-BLT WELDED F/S	1.000 EA
37CB3006	37 CB CASTING W/1.38 LEAD HOLE @ 6:00	1.000 EA
37GS1000SP	GASKET, CONDUIT BOX STD., .06 THICK LEXI	1.000 EA
51XW2520A12	.25-20 X .75, TAPTITE II, HEX WSHR SLTD	2.000 EA
11XW1032G06	10-32 X .38, TAPTITE II, HEX WSHR SLTD U	1.000 EA
37EP3101A29	FR ENDPLATE, FOR ROUTING PURPOSES	1.000 EA
HW4500A01	1641B(ALEMITE)400 UNIV, GREASE FITT	1.000 EA
HW4500A17	317400 ALEMITE GREASE RELIEF	1.000 EA
HW5100A06	W2420-025 WVY WSHR (WB)	1.000 EA
37EP3401T10	EP PU ENCL 309 BRG W/GRSR & RELIEF, META	1.000 EA
HW4500A01	1641B(ALEMITE)400 UNIV, GREASE FITT	1.000 EA
HW4500A17	317400 ALEMITE GREASE RELIEF	1.000 EA
10XN2520A36	1/4-20X 2 1/4 HEX HD X	4.000 EA
XY3118A12	5/16-18 HEX NUT DIRECTIONAL SERRATION	4.000 EA
51XB1214A20	12-14X1.25 HXWSSLD SERTYB	1.000 EA
07FH4007SP	PRIMED	1.000 EA
51XW1032A06	10-32 X .38, TAPTITE II, HEX WSHR SLTD S	3.000 EA
37CB4516	LIPPED LID FOR 37 FRAME NEC KOBX	1.000 EA
37GS1008	37 GS FOR CB LID - LEXIDE	1.000 EA
51XW0832A07	8-32 X .44, TAPTITE II, HEX WSHR SLTD SE	4.000 EA
HA2009A02	SLINGER MODEL 37 PUMP MOTORS-2.75 DIA. A	1.000 EA

Parts List (continued)		
Part Number	Description	Quantity
HW2501D13	KEY, 3/16 SQ X 1.375	1.000 EA
HA7000A01	KEY RETAINER 7/8" DIA SHAFT	1.000 EA
80XN1032A06	10-32 X 3/8 SET SC HEX SOCK	1.000 EA
85XU0407S04	4X1/4 U DRIVE PIN STAINLESS	2.000 EA
LB1115N	LABEL,LIFTING DEVICE (ON ROLLS)	1.000 EA
MJ1000A02	GREASE, MOBIL POLYREX EM - 124047	0.050 LB
MG1000Y03	MUNSELL 2.53Y 6.70/ 4.60, GLOSS 20,	0.028 GA
HA3104A25	THRUBOLT .31-18 X 14.75	4.000 EA
LC0181	CONNECTION LABEL	1.000 EA
NP3441L	ALUM SUPER-E VPWM INVERTER READY UL	1.000 EA
37PA1039	PALLET PACK GRP, PRINT PK1026A06	1.000 EA
MN416A01	TAG-INSTAL-MAINT no wire (1200/bx) 3/19	1.000 EA
LB1119N	WARNING LABEL	1.000 EA

AC Induction Motor Performance Data

Record # 53380 - Typical performance - not guaranteed values

Winding: 37WGR228-R023	Type: 3752M	Enclosure: TEFC
-------------------------------	--------------------	------------------------

Nameplate Data				460 V, 60 Hz: High Voltage Connection	
Rated Output (HP)	15			Full Load Torque	22.12 LB-FT
Volts	230/460			Start Configuration	direct on line
Full Load Amps	34/17			Breakdown Torque	103 LB-FT
R.P.M.	3500			Pull-up Torque	40.16 LB-FT
Hz	60	Phase	3	Locked-rotor Torque	57.59 LB-FT
NEMA Design Code	A	KVA Code	J	Starting Current	150 A
Service Factor (S.F.)	1.15			No-load Current	5.55 A
NEMA Nom. Eff.	91	Power Factor	89	Line-line Res. @ 25°C	0.47 Ω
Rating - Duty	40C AMB-CONT			Temp. Rise @ Rated Load	68°C
S.F. Amps				Temp. Rise @ S.F. Load	79°C
				Locked-rotor Power Factor	30.9
				Rotor inertia	0.474 LB-FT ²

Load Characteristics 460 V, 60 Hz, 15 HP

% of Rated Load	25	50	75	100	125	150	S.F.
Power Factor	56	78	85	89	90	90	89
Efficiency	86.8	91	91.9	91.4	90.8	89.8	91.3
Speed	3579	3557	3534	3500	3484	3456	3495
Line amperes	6.7	9.57	13.19	17.03	21.12	25.61	19.5

Performance Graph at 460V, 60Hz, 15.0HP Typical performance - Not guaranteed values

ABB Motors and Mechanical Inc.

WINDING # 37WGR228

Typical performance - not guaranteed values.

15 HP 3 PH 60 HZ 3500 RPM 460 V 3752M

TORQUES(LB-FT): PO=103 PU=40.16 LR=57.59 LRA=150

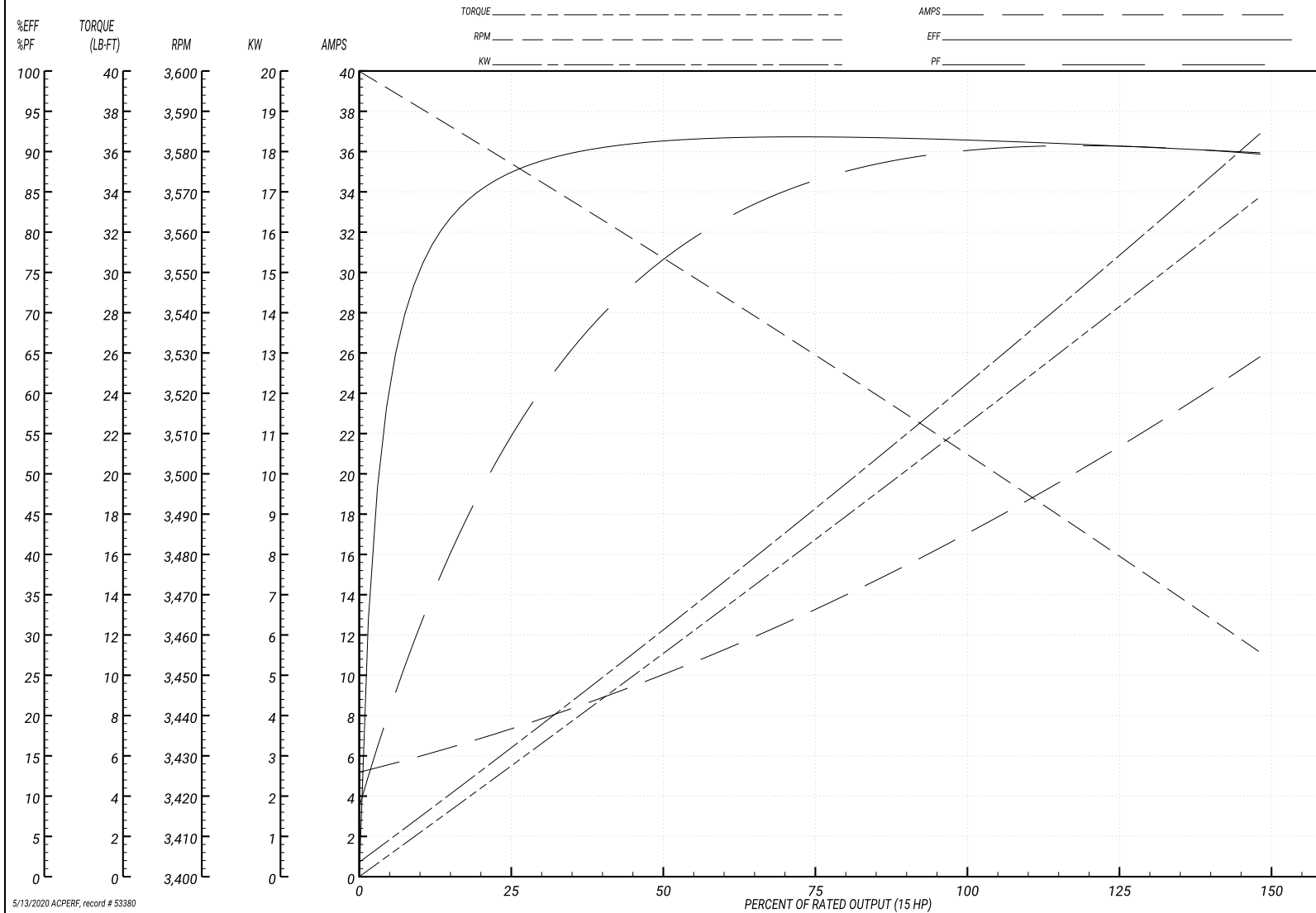

5/13/2020 ACPERF, record # 53380

AC Induction Motor Performance Data

Record # 57899 - Typical performance - not guaranteed values

Winding: 37WGR228-R023	Type: 3752M	Enclosure: TEFC
-------------------------------	--------------------	------------------------

Nameplate Data				230 V, 60 Hz: Low Voltage Connection	
Rated Output (HP)	15			Full Load Torque	22.1 LB-FT
Volts	230/460			Start Configuration	direct on line
Full Load Amps	34/17			Breakdown Torque	104 LB-FT
R.P.M.	3500			Pull-up Torque	40.3 LB-FT
Hz	60	Phase	3	Locked-rotor Torque	57.8 LB-FT
NEMA Design Code	A	KVA Code	J	Starting Current	300 A
Service Factor (S.F.)	1.15			No-load Current	11.1 A
NEMA Nom. Eff.	91	Power Factor	89	Line-line Res. @ 25°C	0.111 Ω
Rating - Duty	40C AMB-CONT			Temp. Rise @ Rated Load	67°C
S.F. Amps				Temp. Rise @ S.F. Load	82°C
				Locked-rotor Power Factor	30.3
				Rotor inertia	0.474 LB-FT ²

Load Characteristics 230 V, 60 Hz, 15 HP

% of Rated Load	25	50	75	100	125	150	S.F.
Power Factor	56	77	85	89	90	90	90
Efficiency	86.8	91.1	92	91.8	91	90	91.3
Speed	3579	3558	3534	3510	3485	3456	3495
Line amperes	13.4	19.1	26.4	34	42.2	51.2	38.9

Performance Graph at 230V, 60Hz, 15.0HP Typical performance - Not guaranteed values

ABB Motors and Mechanical Inc.

WINDING # 37WGR228

Typical performance - not guaranteed values.

15 HP 3 PH 60 HZ 3500 RPM 230 V 3752M
 TORQUES(LB-FT): PO=104 PU=40.3 LR=57.8 LRA=300

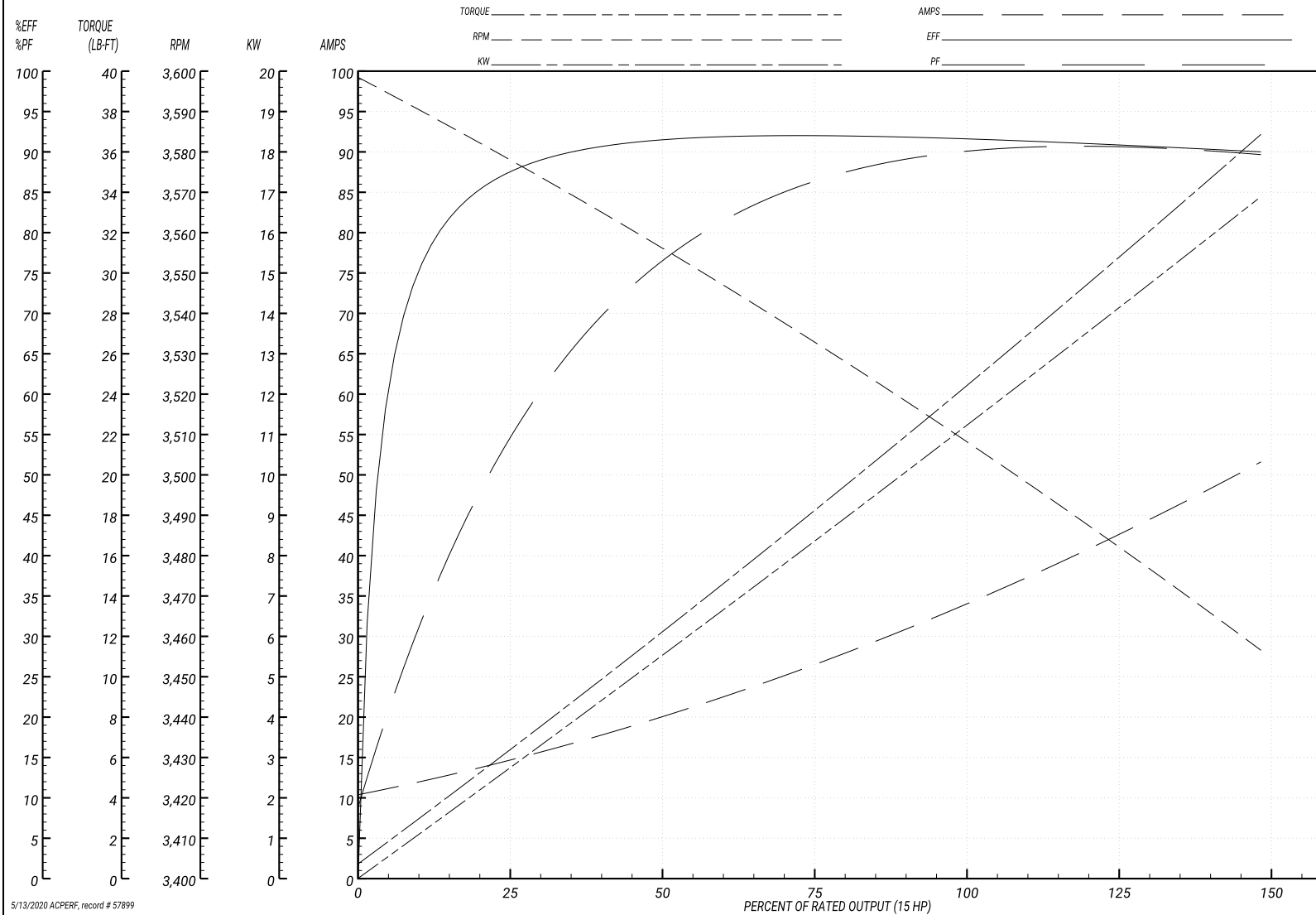

5/13/2020 ACPERF, record # 57899

AC Induction Motor Performance Data

Record # 70097 - Typical performance - not guaranteed values

Winding: 37WGR228-RXXX	Type: 3752M	Enclosure: TEFC
-------------------------------	--------------------	------------------------

Nameplate Data				380 V, 50 Hz: High Voltage Connection	
Rated Output (HP)	15			Full Load Torque	17.68 LB-FT
Volts	230/460			Start Configuration	direct on line
Full Load Amps	34/17			Breakdown Torque	98.71 LB-FT
R.P.M.	3500			Pull-up Torque	42.31 LB-FT
Hz	60	Phase	3	Locked-rotor Torque	60.68 LB-FT
NEMA Design Code	A	KVA Code	J	Starting Current	146 A
Service Factor (S.F.)	1.15			No-load Current	5.43 A
NEMA Nom. Eff.	91	Power Factor	89	Line-line Res. @ 25°C	0.47 Ω
Rating - Duty	40C AMB-CONT			Temp. Rise @ Rated Load	52°C
S.F. Amps				Temp. Rise @ S.F. Load	63°C
				Locked-rotor Power Factor	34.6
				Rotor inertia	0.474 LB-FT ²

Load Characteristics 380 V, 50 Hz, 10 HP

% of Rated Load	25	50	75	100	125	150	S.F.
Power Factor	51	73	82	87	89	90	88
Efficiency	81.7	88	89.8	89.9	89.6	88.9	89.7
Speed	2982	2964	2945	2918	2905	2883	2910
Line amperes	6.27	8.45	11.29	14.27	17.46	20.98	16.2

Performance Graph at 380V, 50Hz, 10.0HP Typical performance - Not guaranteed values

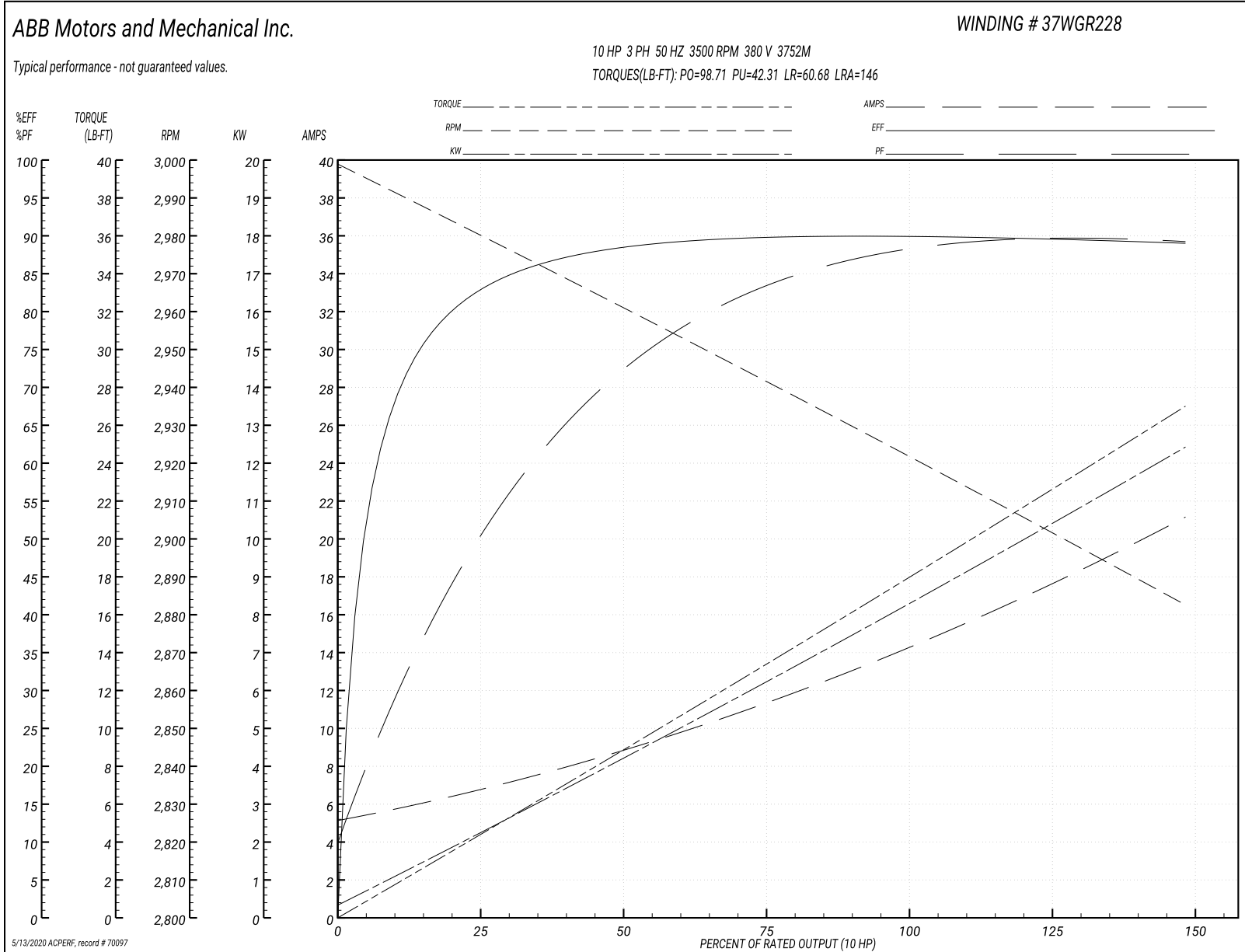

AC Induction Motor Performance Data

Record # 73419 - Typical performance - not guaranteed values

Winding: 37WGR228-RXXX	Type: 3752M	Enclosure: TEFC
-------------------------------	--------------------	------------------------

Nameplate Data				480 V, 60 Hz: High Voltage Connection	
Rated Output (HP)	15			Full Load Torque	22.12 LB-FT
Volts	230/460			Start Configuration	direct on line
Full Load Amps	34/17			Breakdown Torque	113 LB-FT
R.P.M.	3500			Pull-up Torque	44.76 LB-FT
Hz	60	Phase	3	Locked-rotor Torque	64.18 LB-FT
NEMA Design Code	A	KVA Code	J	Starting Current	159 A
Service Factor (S.F.)	1.15			No-load Current	6.32 A
NEMA Nom. Eff.	91	Power Factor	89	Line-line Res. @ 25°C	0.47 Ω
Rating - Duty	40C AMB-CONT			Temp. Rise @ Rated Load	67°C
S.F. Amps				Temp. Rise @ S.F. Load	83°C
				Locked-rotor Power Factor	31.2
				Rotor inertia	0.474 LB-FT ²

Load Characteristics 480 V, 60 Hz, 15 HP

% of Rated Load	25	50	75	100	125	150	S.F.
Power Factor	50	72	82	86	88	89	87
Efficiency	86.2	90.7	91.8	91.5	90.9	90.1	91.1
Speed	3580	3560	3538	3506	3491	3465	3497
Line amperes	7.28	9.85	13.18	16.77	20.58	24.75	19.1

Performance Graph at 480V, 60Hz, 15.0HP Typical performance - Not guaranteed values

ABB Motors and Mechanical Inc.

WINDING # 37WGR228

Typical performance - not guaranteed values.

15 HP 3 PH 60 HZ 3500 RPM 480 V 3752M

TORQUES(LB-FT): PO=113 PU=44.76 LR=64.18 LRA=159

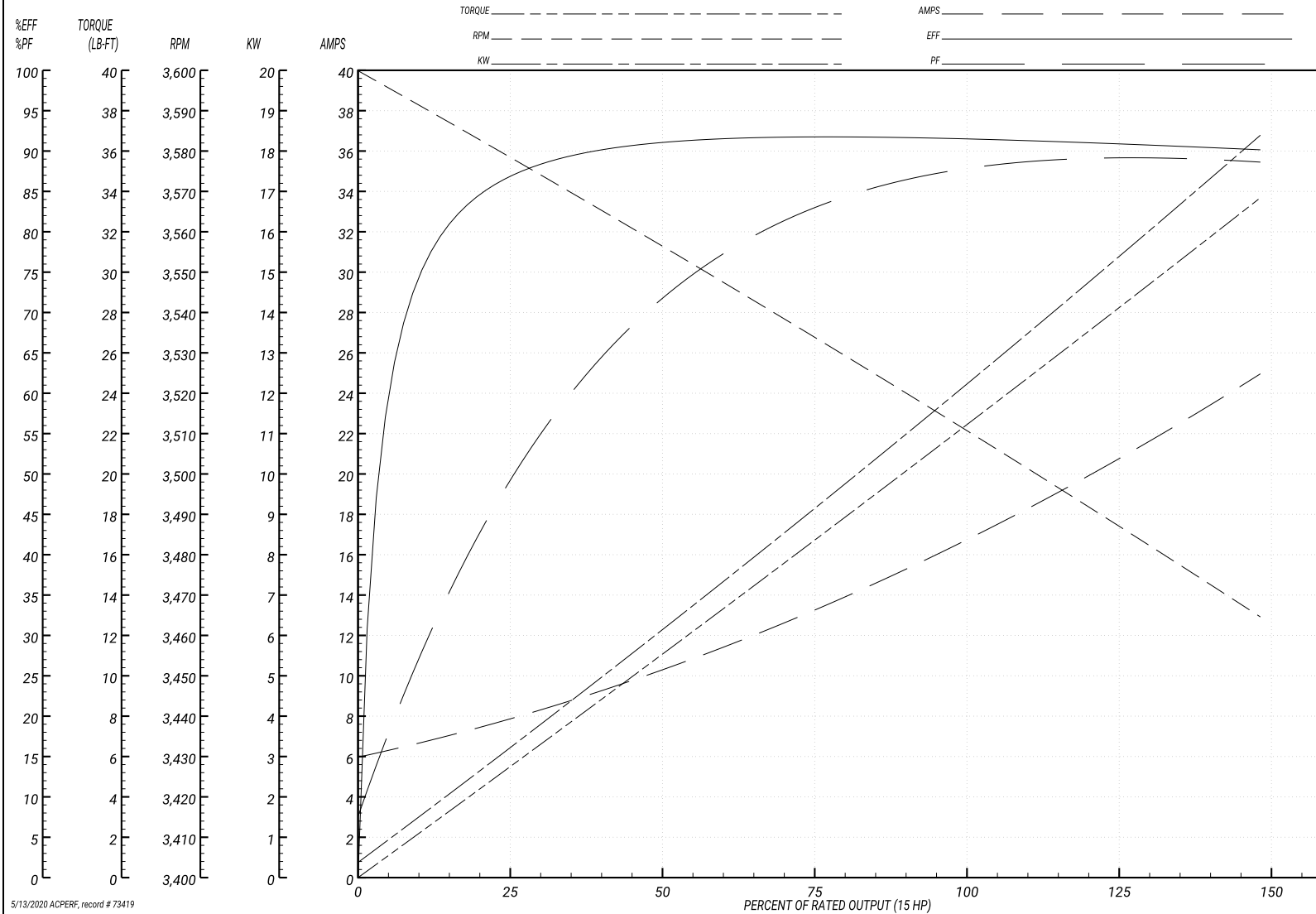

5/13/2020 ACPERF, record # 73419

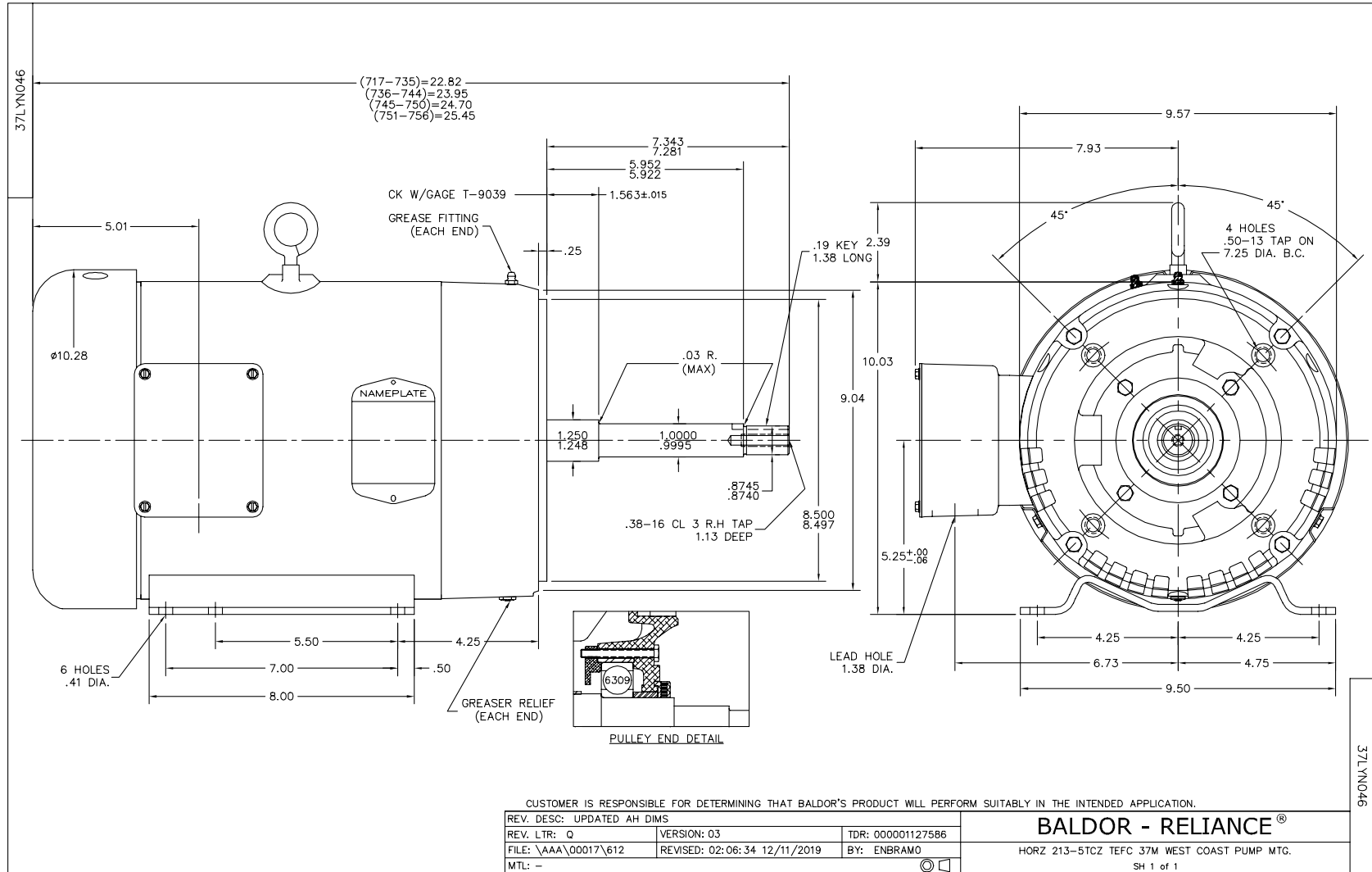

CD0180

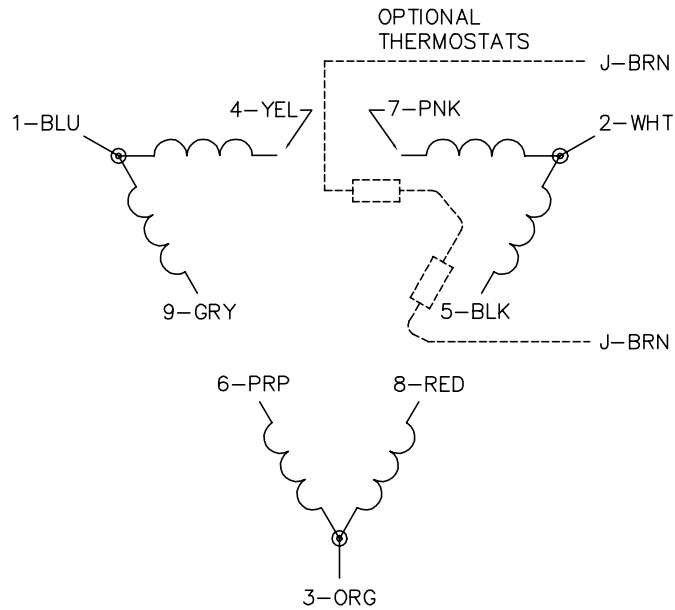

LOW VOLTAGE
(2D)

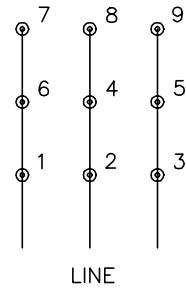

HIGH VOLTAGE
(1D)

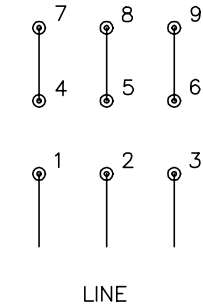

NOTES:

1. INTERCHANGE ANY TWO LINE LEADS TO REVERSE ROTATION.
2. OPTIONAL THERMOSTATS ARE PROVIDED WHEN SPECIFIED.
3. ACTUAL NUMBER OF INTERNAL PARALLEL CIRCUITS MAY BE A MULTIPLE OF THOSE SHOWN ABOVE.
4. LEAD COLORS ARE OPTIONAL. LEADS MUST ALWAYS BE NUMBERED AS SHOWN.

CD0180

REV. DESC: ADD CLASS CONN00000007		
REV. LTR: D	VERSION: 01	TDR: 000001099922
FILE: \AAA\00005\148	REVISED: 10:25:29 02/19/2019	BY: ENBRIRO
MTL: -	© □	

BALDOR - RELIANCE®

3PH, DV, 9 LEADS, DELTA CONNECTION

SH 1 of 1